



BT fixo

LINHA COMPLETA DE PRODUTOS 2023

ROSQUEADEIRAS

BTfixo

ROSQUEADEIRA ELETRÔNICA COM BRAÇO ARTICULADO
Modelo: RE

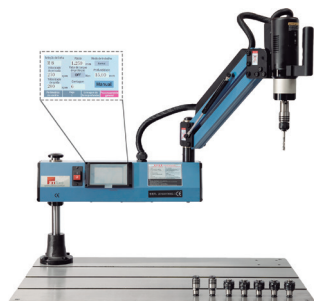

Acessório opcional:



Para maiores informações
escaneie o QR code acima

ROSQUEADEIRA CNC SEMI-AUTOMÁTICA
Modelo: CNA12



MAGNÉTICOS

MESA MAGNÉTICA
Modelo: MMC-2025, 2040,
3040, 3060



BLOCO MAGNÉTICO
Modelo: SYT-150A, 200A



MESA MAGNÉTICA ELETROPERMANENTE
Modelo: PEMM-3040, 3060



MESA DE SENO MAGNÉTICA PERMANENTE
Modelo: PMSM-1515, 1530



MESA MAGNÉTICA PERMANENTE
Modelo: PMR41-1015, 1515, 1020, 1520, 1530,
3040, 3060



BLOCO MAGNÉTICO
Modelo: ECMC - 220
Item somente sob encomenda



LEVANTADOR MAGNÉTICO
Modelo: LS1-0.2, 0.4, 0.6, 1, 2, 3



PINÇAS MAGNÉTICAS DE SEGURANÇA SIMPLES
Modelo: SP



PINÇAS MAGNÉTICAS DE SEGURANÇA DUPLA
Modelo: TP



DIVISORES

SUPER DIVISOR
Modelo: HSD-7



Item somente sob encomenda

DIVISOR UNIVERSAL
Modelo: BS-2



DIVISOR SEMI UNIVERSAL
Modelo: BS-1

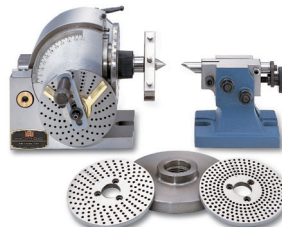

CONJUNTO CABEÇOTE ÂNGULO RETO
NT/ISO-40



MESA DIVISORA VERTICAL/HORIZONTAL
Modelo: HHV-200, 250, 300 e acessórios conforme catálogo

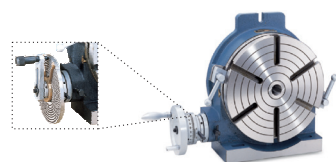

CONTRA PONTO
Modelo: TS-1 e 2



MORSAS



MORSA MECÂNICA ANGULAR
Modelo: HHY-100, 150

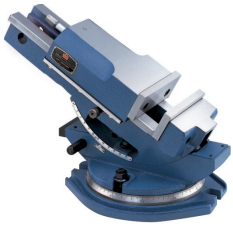

MORSA HIDRÁULICA ANGULAR
Modelo: HW-100, 150



MORSA MECÂNICA
Modelo: H-400, 600



MORSA HIDRÁULICA
Modelo: H-100, 125, 150, 200



MORSA ANGULAR UNIVERSAL
Modelo: HY-3, 4, 5



MORSA DE PRECISÃO
Modelo: QKG

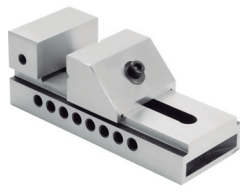

MORSA DE PRECISÃO
Modelo: GTI-150, GTI-200, GTI-300, GTI-400

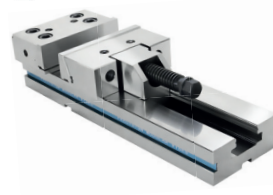

MORSA DE PRECISÃO CNC
Modelo: HVV-4, 6, 8

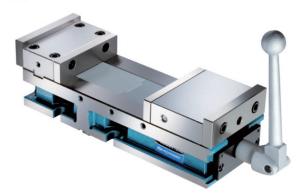

MORSA DE PRECISÃO CNC DE ÂNGULO ABERTO
Modelo: GH-6

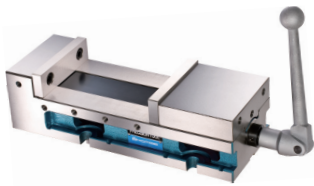

MORSA AUTOCENTRANTE
Modelo: SC-1-4"



MORSA COMPACTA DUPLA DE PRECISÃO
Modelo: CD-4"



MORSA AUTOCENTRANTE AJUSTÁVEL
Modelo: ASC-100x125", 130x195", 130x250", 160x300"



PATENTED

MORSA UNIVERSAL DE PRECISÃO
Modelo: CHM-80



MORSA DUPLA DE PRECISÃO CNC
Modelo: HDL-4"



PATENTED 126219

MORSA PARA CNC MULTI-POWER
Modelo: HPAQ-160



PATENTED 142711, M278511, M287204, M320459, M338717

MORSA PARA CNC MULTI-POWER DE ÂNGULO FIXO
Modelo: HPAC-130



PATENTED 142711, M287204, M320459

MORSA PARA CNC MULTI-POWER DE ÂNGULO FIXO
Modelo: HPAC-130S

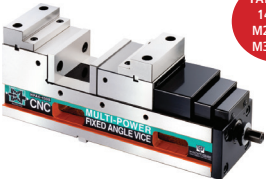

PATENTED 142711, M287204, M320459

MORSA DE PRECISÃO PARA PRODUÇÃO
Modelo: HRV-5040, 5050, 7553



MORSA DE PRECISÃO PARA PRODUÇÃO EM MÓDULO
Modelo: HRV-5013 (A, B, C, D, E)

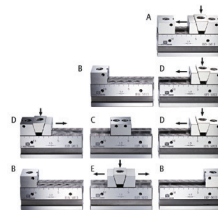

MINI MORSA

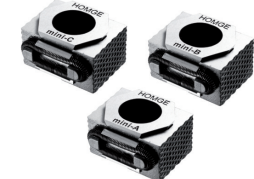

MORSA DE SENO
Modelo: VX



JOGO DE CALÇO PADRÃO



CANTONEIRA DE FERRO FUNDIDO
Modelo: HL-6", 8", 10", 12"



MESA ANGULAR
Modelo: TT-7", 10", 15"

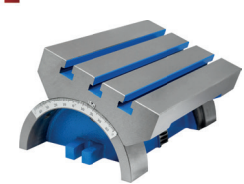

MANDRIS DUPLO CONTATO



PORTA PINÇA DBT - HQT
High Quality Tools



PORTA FRESA FACEAR DBT - HQT
High Quality Tools



PORTA PINÇA AUTO TORQUE DBT - HQT
High Quality Tools



MAS 403 BT

PORTA PINÇA (DMC)
(MAS 403 BT)



PORTA PINÇA AUTO TORQUE
(MAS 403 BT)



MANDRIL FLUTUANTE TROCA RÁPIDA
(MAS 403 BT)

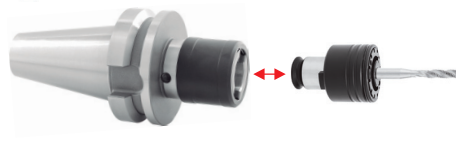

PORTA PINÇA ER (com Compensação Axial)
(MAS 403 BT)



PORTA PINÇA ER - SYNCHRO
(MAS 403 BT)



CONE INDUÇÃO TÉRMICA SHRINK FIT
(MAS 403 BT)



PORTA PINÇA SK
(MAS 403 BT)



PORTA PINÇA HIDRÁULICO
(MAS 403 BT)



PORTA PINÇA COM REFRIGERAÇÃO LATERAL
(MAS 403 BT)



PORTA BARRA WELDON COM REFRIGERAÇÃO LATERAL
(MAS 403 BT)



BUCHA PARA PORTA BARRA COM REFRIGERAÇÃO LATERAL

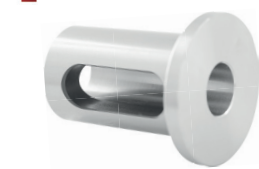

PORTA PINÇA ER - HQT
High Quality Tools
(MAS 403 BT)



PORTA PINÇA ER
(MAS 403 BT)



PORTA BARRA WELDON
(MAS 403 BT)



PORTA BARRA WELDON - HQT
High Quality Tools
(MAS 403 BT)



CONE MODULAR
(MAS 403 BT)



PORTA FRESA COMBINADO
(MAS 403 BT)



PORTA FRESA ROSCADO (Porta Cápsula)
(MAS 403 BT)



PORTA FRESA FACEAR
(MAS 403 BT) / (DIN3937)



CONE REDUÇÃO
(MAS 403 BT)

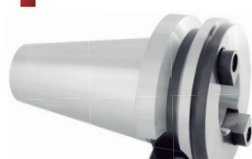

PORTA CONE MORSE
(MAS 403 BT)



HASTE PARA MANDRIL
(MAS 403 BT)



MANDRIL APERTO RÁPIDO INTEGRADO
(MAS 403 BT)



DIN 69871-SK

PORTA PINÇA (DMC)
(DIN 69871)



PORTA PINÇA AUTO TORQUE
(DIN 69871)



MANDRIL FLUTUANTE TROCA RÁPIDA
(DIN 69871)



PORTA PINÇA SK
(DIN 69871)



PORTA PINÇA HIDRÁULICO
(DIN 69871)



PORTA PINÇA ER - HQT
(DIN 69871)



PORTA PINÇA ER
(DIN 69871)



PORTA BARRA WELDON
(DIN 69871)



CONE MODULAR
(DIN 69871)



PORTA FRESA COMBINADO
(DIN 69871)



PORTA FRESA ROSCADO (Porta Cápsula)
(DIN 69871)



PORTA FRESA FACEAR
(DIN 69871)



PORTA CONE MORSE
(DIN 69871)



HASTE PARA MANDRIL
(DIN 69871)



MANDRIL APERTO RÁPIDO INTEGRADO
(DIN 69871)



DIN 69893-HSK (Forma A)

PORTA PINÇA (DMC)
(DIN 69893)



PORTA PINÇA AUTO TORQUE
(DIN 69893)



PORTA PINÇA HIDRÁULICO
(DIN 69893)



CONE INDUÇÃO TÉRMICA SHRINK FIT
(DIN 69893)



PORTA PINÇA SK
(DIN 69893)



PORTA PINÇA ER
(DIN 69893)



PORTA BARRA WELDON
(DIN 69893)



PORTA FRESA ROSCADO - HSK
(DIN 69893)



PORTA FRESA FACEAR
(DIN 69893) / (DIN 3937)



DIN 69893-HSK (Forma E)

PORTA PINÇA (DMC)
(DIN 69893) / (Forma E)



PORTA PINÇA HIDRÁULICO
(DIN 69893) / (Forma E)



PORTA PINÇA SK
(DIN 69893) / (Forma E)



PORTA PINÇA ER
(DIN 69893) / (Forma E)



DIN 69893-HSK (Forma F)

PORTA PINÇA ER
(DIN 69893) / (Forma F)



DIN ISO20 / DIN ISO30

PORTA PINÇA
ISO20



PORTA PINÇA ER
ISO30



DIN 2080 ISO

PORTA PINÇA
(DIN 2080)



PORTA BARRA WELDON
(DIN 2080)



PORTA FRESA COMBINADO
(DIN 2080) / (DIN 3937)



PORTA FRESA FACEAR
(DIN 2080) / (DIN 3937)



PORTA CONE MORSE
(DIN 2080)



HASTE PARA MANDRIL
(DIN 2080)



CONE MORSE DIN 228

PORTA PINÇA ER
(DIN 228 A)



PORTA PINÇA ER
(DIN 228 B)



PORTA FRESA FACEAR
(DIN 228 A)



HASTE CÔNICA
(DIN 228 B)



BUCHA DE REDUÇÃO
(DIN 228 B)



MANDRIL FLUTUANTE TROCA RÁPIDA
(DIN 228 B)



CABEÇOTE ROSQUEADOR
(DIN 228 B)



HASTE PARALELA

PORTA PINÇA (HASTE PARALELA) - (DMC)



PORTA PINÇA (HASTE PARALELA)



HASTE PARALELA PARA MANDRIL



PORTA ALARGADOR FLUTUANTE



PORTA PINÇA (HASTE PARALELA) Com Compensação Axial



MANDRIL RÍGIDO TROCA RÁPIDA (CONE INTERNO)

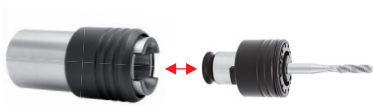

MANDRIL FLUTUANTE TROCA RÁPIDA (HASTE PARALELA)



PORTA PINÇA (HASTE PARALELA) SYNCHRO



LINHA MODULAR

CONE MODULAR (MAS 403 BT)



CONE MODULAR (DIN 69871)

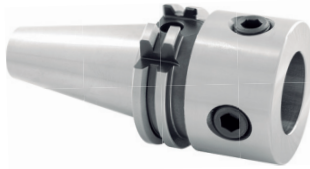

PROLONGADOR PARA CONE MODULAR

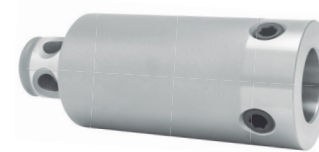

PROLONGADOR PORTA FRESA FACEAR PARA CONE MODULAR



PROLONGADOR PORTA BARRA WELDON - PARA CONE MODULAR

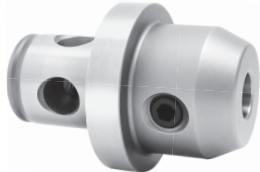

PROLONGADOR PORTA PINÇA ER PARA CONE MODULAR



MÁQUINAS DE INDUÇÃO TÉRMICA

MÁQUINA DE INDUÇÃO TÉRMICA
Modelo: GTS-306



MÁQUINA DE INDUÇÃO TÉRMICA
Modelo: GTS-9000
Item somente sob encomenda



JOGOS DE PINÇAS



JOGO DE PINÇAS ER (CAIXA DE PLÁSTICO)

Modelos: ER-11, ER-16, ER-20, ER-25, ER-32, ER-40, ER-50



JOGO DE PINÇAS ER COM CONE E CHAVE

Modelos: BT-30, BT-40, CM-3, CM-4, CM-5, ISO-30, ISO-40



JOGO DE PINÇAS VEDADA ER

Modelos: ER-16, ER-25, ER-32, ER-40



JOGO DE PINÇAS OZ

Modelo: OZ-25



JOGO DE PINÇAS OZ COM CONE E CHAVE

Modelo: ISO-40



PINÇAS

PINÇA ER SELADA (VEDADA)

(DIN 6499)



PINÇA ER

(DIN 6499)



PINÇA PORTA MACHO COM COMPENSAÇÃO AXIAL

(DIN 6499)



PINÇA PORTA MACHO



PINÇA OZ

(DIN 6388A)



PINÇA (DMC)



PINÇA SK



PINÇA PARA CONE HIDRÁULICO (VEDADA)

(REDUÇÃO)



PINÇA PARA CONE AUTO TORQUE

(REDUÇÃO)



PINÇA PARA AFIADORA



ACESSÓRIOS



PORCA PARA PINÇA



PORCA PARA ANÉIS DE VEDAÇÃO



CHAVES PARA PORCA



PINO DE FIXAÇÃO



PINO ADAPTADOR BT PARA ISO (DIN2080)



DISPOSITIVO DE APERTO CALIBRADOR PARA PINOS E PORCAS Modelo: HT07



PONTEIRA COM ENCAIXE TIPO E (4 PONTAS) PARA DISPOSITIVO DE APERTO Modelo: TWR05



PONTEIRA COM ENCAIXE TIPO UNHA PARA DISPOSITIVO DE APERTO Modelo: TWR06



PONTEIRA COM ENCAIXE SEXTAVADO PARA DISPOSITIVO DE APERTO Modelo: TWR07



BUCHA EXCÊNTRICA PARA AJUSTE DO CENTRO DA BROCA



ADAPTADOR PARA TROCA RÁPIDA Sem Embreagem de Segurança



ADAPTADOR PARA TROCA RÁPIDA Com Embreagem de Segurança



ADAPTADOR PARA TROCA RÁPIDA Sem Embreagem de Segurança (Porta Pinça)



REDUÇÃO PARA ADAPTADOR



DISPOSITIVO DE APERTO CALIBRADOR Modelo: MTD6-NS



PONTEIRA TORX COM ENCAIXE 1/4" SEXTAVADO



TUBO DE REFRIGERAÇÃO PARA CONE HSK



CHAVE PARA TUBO DE REFRIGERAÇÃO



LUMINÁRIA LED



SUORTE PARA TROCA DE FERRAMENTAS

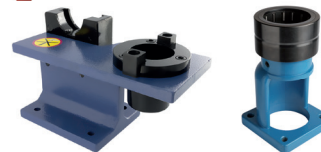

PRESSETER COM RELÓGIO



PRESSETER ELETRÔNICO



PRESSETER DIGITAL



LOCALIZADOR DE ARESTAS Modelo: CB-00, CB-01



SENSOR DE LOCALIZAÇÃO COM BIP E LED



ACESSÓRIOS

FLEXÍVEL PLÁSTICO - JOGO



FLEXÍVEL PLÁSTICO

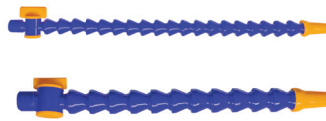

BLOCO EM V - MAGNÉTICO

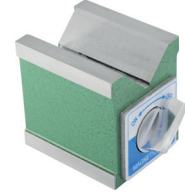

BASE MAGNÉTICA ARTICULADA COM AJUSTE FINO



SUPORE PARA TRANSPORTE DE FERRAMENTAS E SUPORE DE BANCADA



RELÓGIO APALPADOR

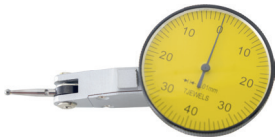

MANDRIL

MANDRIL COM CHAVE LINHA LEVE



MANDRIL COM CHAVE LINHA PESADA



MANDRIL COM CHAVE LINHA PESADA EXTRA



MANDRIL DE APERTO RÁPIDO



MANDRIL DE APERTO RÁPIDO SUPER

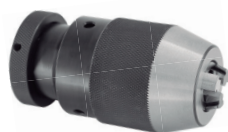

CHAVE PARA MANDRIL



CHAVE PARA MANDRIL APERTO RÁPIDO SUPER



PLACAS



PLACA AUTOCENTRANTE
COM 3 CASTANHAS MONOBLOCO
FIXAÇÃO TRASEIRA



PLACA AUTOCENTRANTE
COM 3 CASTANHAS MONOBLOCO
FIXAÇÃO FRONTAL



PLACA AUTOCENTRANTE
COM 3 CASTANHAS MONOBLOCO
FIXAÇÃO FRONTAL - CORPO DE AÇO



PLACA AUTOCENTRANTE
COM 3 CASTANHAS REVERSÍVEIS
FIXAÇÃO TRASEIRA



PLACA AUTOCENTRANTE
COM 3 CASTANHAS REVERSÍVEIS
FIXAÇÃO FRONTAL



PLACA AUTOCENTRANTE
COM 3 CASTANHAS REVERSÍVEIS
FIXAÇÃO FRONTAL - CORPO DE AÇO



PLACA AUTOCENTRANTE
COM 4 CASTANHAS MONOBLOCO
FIXAÇÃO TRASEIRA



PLACA AUTOCENTRANTE
COM 4 CASTANHAS REVERSÍVEIS
FIXAÇÃO TRASEIRA



PLACA INDEPENDENTE
COM 4 CASTANHAS MONOBLOCO

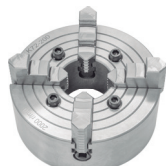

PLACA AUTOCENTRANTE
COM 3 CASTANHAS MONOBLOCO
FIXAÇÃO CAMLOCK



PLACA AUTOCENTRANTE
COM 3 CASTANHAS REVERSÍVEIS
FIXAÇÃO CAMLOCK



PLACA AUTOCENTRANTE
COM 6 CASTANHAS MONOBLOCO
FIXAÇÃO TRASEIRA



PLACA AUTOCENTRANTE
COM 3 CASTANHAS MONOBLOCO
COM HASTE CÔNICA



FLANGE CONE CURTO PARA PLACAS
UNIVERSAIS E INDEPENDENTES

ASA B-5.9-1960
CAMLOCK



ASA B-5.9-1954
TIPO L



PLACA PARA CENTRO DE
USINAGEM COM 3 CASTANHAS

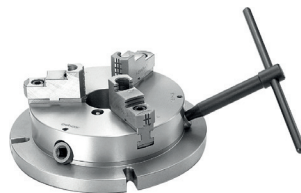

PLACA PARA CENTRO DE
USINAGEM COM 4 CASTANHAS

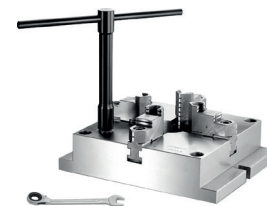

PLACA HIDRÁULICA



PEÇAS DE REPOSIÇÃO



Anel Espiral



Pinhão



Chave para placa

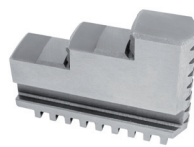

Castanhas
Monobloco Externa

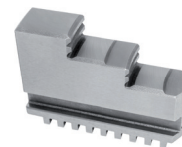

Castanhas
Monobloco Interna

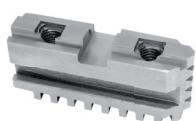

Castanhas Base

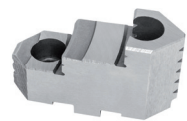

Castanhas Sobreposta



CASTANHA MOLE



GUIA PARA CASTANHA MOLE

PONTOS



PONTO ROTATIVO



PONTO ROTATIVO CARGA LEVE



PONTO ROTATIVO PRECISÃO



Modelo A



Modelo B

PONTO ROTATIVO COMPACT



Modelo A



Modelo B



Modelo I

PONTO ROTATIVO PARA TUBO (Orbital)



PONTO ROTATIVO HIGH SPEED



Modelo A



Modelo B



Modelo I

PONTO ROTATIVO SUPER CARGA



PONTO ROTATIVO HIGH PERFORMANCE



Modelo A



Modelo B

PONTO ROTATIVO SUPER HIGH SPEED



Modelo A



Modelo B

PONTO FIXO DE ARRASTE

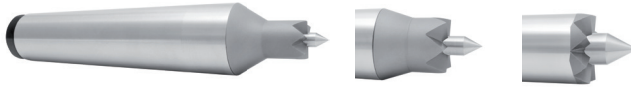

PONTO FIXO COM INSERTO DE METAL DURO



PONTO FIXO HSS



PONTO FIXO HSS PONTA ESTENDIDA COM PORCA EXTRATORA



PONTO FIXO HSS COM PORCA EXTRATORA



PONTO DE ARRASTE



PONTO DE ARRASTE



BUCHA PARA PONTO DE ARRASTE



PONTO DE ARRASTE FRONTAL



REPOSIÇÃO DE PONTEIRAS PARA PONTOS ROTATIVOS COM PONTAS INTERCAMBIÁVEIS



H230



H212



H210



H208



H206



H205



H200

VDI LATERAL (RADIAL) DIREITO
(DIN 69880 B1)



VDI LATERAL (RADIAL) ESQUERDO
(DIN 69880 B2)



VDI LATERAL (RADIAL) DIREITO INV.
(DIN 69880 B3)



VDI LATERAL (RADIAL) ESQUERDO INV.
(DIN 69880 B4)



VDI FRONTAL (AXIAL) DIREITO
(DIN 69880 C1)



VDI FRONTAL (AXIAL) ESQUERDO
(DIN 69880 C2)



VDI FRONTAL (AXIAL) DIREITO INV.
(DIN 69880 C3)



VDI FRONTAL (AXIAL) ESQUERDO INV.
(DIN 69880 C4)



VDI PORTA BARRA WELDON
(DIN 69880 E2)



VDI PORTA PINÇA ER (DIN 6499)
(DIN 69880 E4)



BUCHA REDUÇÃO PARA VDI



ACESSÓRIOS DE FIXAÇÃO

JOGO DE PRESILHAS PARA FIXAÇÃO



HQT



ACC

CALÇO REGULÁVEL
(CR-0017)



GRAMPO FECHADO COM PARAFUSO DE ENCOSTO
GF-M12/110 GF-M14/130
GF-M16/150 GF-M20/200



GRAMPO PARA FIXAÇÃO LATERAL
GFL-M12 GFL-M14 GFL-M16



PORCA "T"
(PT-0005)

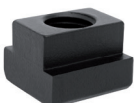

PARAFUSOS CABEÇA "T"
(PCT-0009)



PORCA SEXTAVADA
(PS-0006)



PORCA COM COLAR
(PC-0008)



ARRUELA LISA
(AL-0007)

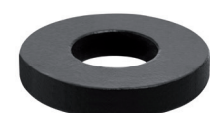

TIRANTE ROSCADO
(TR-0004)



MANDRILHAMENTO



CONE MODULAR CBH



CONE MODULAR CBST

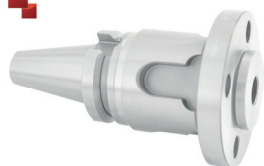

CABEÇOTE MANDRILHAR ACABAMENTO CENTESIMAL



CABEÇOTE MANDRILHAR DESBASTE



KIT DE MANDRILHAMENTO NBH2084 ø8 - ø280



CABEÇOTE BROQUEADOR



HASTES PARA CABEÇOTE BROQUEADOR



MANDRILHAMENTO



TS..
Ø 18 ~ 200



SS..



P20.30



P



PS



B..



TRM..
Ø 16~40



SF..



TRM 50
Ø 2.5 ~ 108



KIT K01
Ø 6 ~ 108



TRM80
Ø 2.5 ~ 160



KIT K01
Ø 6 ~ 125



TRM63
Ø 2.5 ~ 125



TRM50-PSC
Ø 2.5 ~ 108



KIT K01-PSC
Ø 6 ~ 108



MANDRIL AUTO TORQUE - HIGH PRECISION



MAS 403 BT AD+B



DIN 69871 AD+B



DIN 69893 HSK-A



ISO 26623-1 PSC



PINÇA PARA CONE AUTO TORQUE
MONOFORCE (REDUÇÃO)



MANDRIL BÁSICO

MAS 403 BT



MAS 403 BT



DIN 69871



DIN 69871



HSK DIN 69893



DIN 69893



ISO 26623-1 PSC



EXTENSORES E REDUÇÕES

PR



RAV



RD



RD



BMD



CABEÇOTE ANGULAR

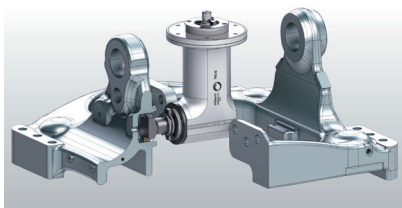

O cabeçote 90° com ou sem flange para grandes peças.

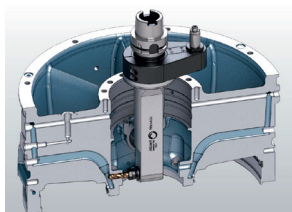

O cabeçote 90° longo

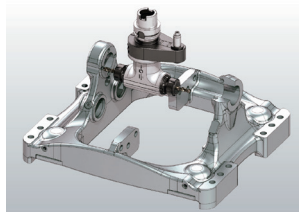

O cabeçote 90° com mandris opostos

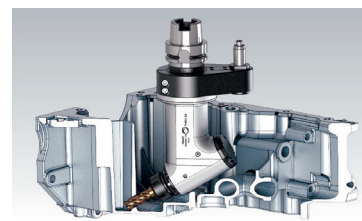

Cabeçote fixo com ângulo variável

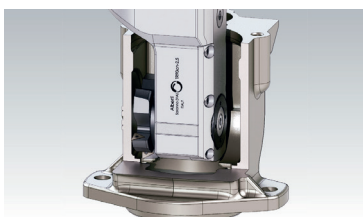

Cabeçote para espaços restritos

LINEA CONTROL

T90cn-1,5

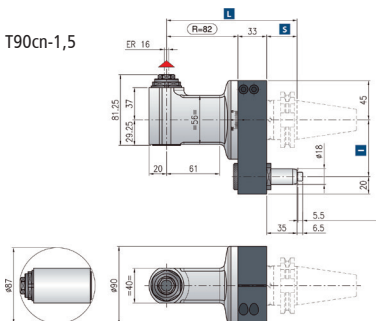

T90cn-2,5

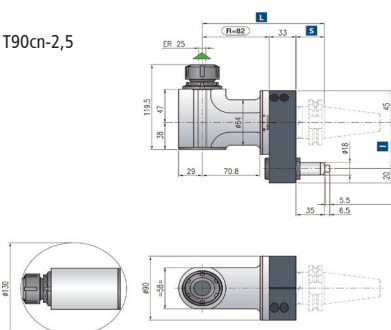

T90cn-3,5

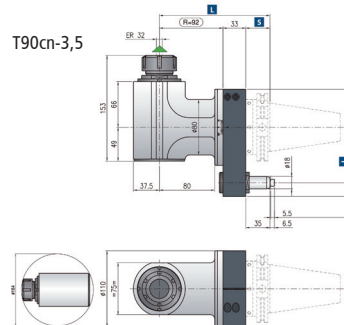

T90cn-5

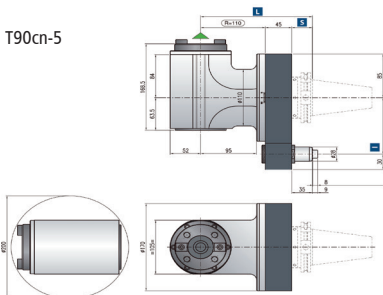

TCUcn-1,5

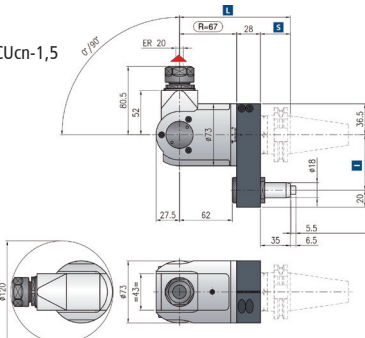

TCUcn-2,5

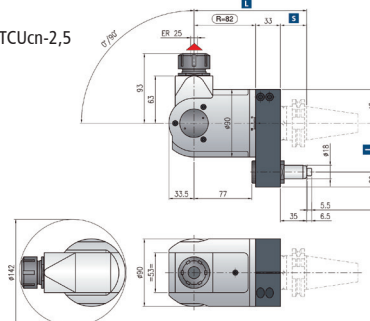

LINEA ALUMINUM

T90cn-3,5M

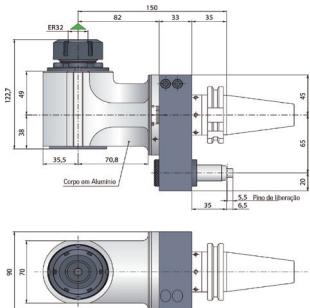



**R. Jacob Cemin, 68 - Nossa Sra. de Fátima,
Caxias do Sul - RS, 95041-230
Fone: (54) 3021-4119
E-mail: vendas@btfixo.com.br
www.btfixo.com.br**